

Balcrank[®]

Lynx 1:1 Pumps

Models: 1110-009 (Drum Length)
1110-010 (Stub)





Thoroughly read and understand this manual before installing, operating or servicing this equipment.

**OPERATION, INSTALLATION,
MAINTENANCE AND REPAIR GUIDE**

GENERAL SAFETY REQUIREMENTS

NOTE: THOROUGHLY READ AND UNDERSTAND THIS MANUAL BEFORE INSTALLING, OPERATING OR SERVICING THIS EQUIPMENT.

	<p>! IMPORTANT</p>
<p>Because this pump can be incorporated into pressurized systems, the following safety precautions should be observed.</p>	
<p>Check equipment regularly and repair or replace worn and damaged parts.</p>	
<p>Never alter or modify any parts of this pump, doing so may cause damage to pump and/or personal injury.</p>	
<p>Under no circumstances should the dispensing valve be aimed at any person at any time. Personal injury may result.</p>	
<p>Release pressures built up in the system before any service or repair is begun. See the pressure relief procedure below.</p>	
<p>Do not operate this pump above 150 PSI (10.3 BAR) air inlet pressure .</p>	
<p>Always read and follow the fluid manufacturer's recommendations regarding the use of protective eyewear, clothing and respirators.</p>	

	<p>! WARNING</p>
<p>PRESSURE RELIEF PROCEDURE: Follow this procedure whenever you shut off the pump, when checking or servicing any part of the system and when installing, cleaning or changing any part of the system.</p>	
<ol style="list-style-type: none"> 1) Disconnect the air to the pump. 2) Point dispensing valve away from yourself and others. 3) Open dispensing valve until pressure is relieved. 	

	<p>NOTE</p>
<p>Note: Thermal expansion of the fluid in a distribution system can cause an increase in system pressure that can damage fluid distribution system components. Pressure relief valve, 3120-019 is recommended.</p>	

	<p>! WARNING</p>
<p>Pump develops 150 PSI (10.3 BAR) maximum working pressure at 150 PSI (10.3 BAR) maximum inlet air pressure. Be sure that any components or accessories used in the system are rated to withstand this pressure. To determine fluid outlet pressure, multiply the ratio of the pump by the air pressure being used.</p> <p>EX: 1.1 (1:1 ratio) x 100 PSI = 100 PSI fluid pressure. 1.1 (1:1 ratio) x 6.9 BAR = 6.9 BAR fluid pressure.</p>	

	<p>! WARNING</p>
<p>DANGER: Not for use with fluids that have a flash point below 100°F (38°C). Examples: gasoline, alcohol. Sparking could result in an explosion which could result in death.</p>	

	<p>! WARNING</p>
<p>In the presence of explosive vapors, take action to prevent static sparking. Failure to ground the pump, piping, valves, containers, or other miscellaneous equipment can result in fire or explosion.</p>	

	<p>! WARNING</p>
<p>Do NOT use with solvents or other explosive fluids. An explosion can result in the pump when aluminum & zinc parts come in contact with certain solvents.</p>	

TABLE OF CONTENTS

Cover.....	1
General Safety Information.....	2
Technical Data.....	3
Dimensional Data.....	3
Installation/Operation.....	4
Servicing.....	5
Troubleshooting.....	5
Parts Listing.....	6 & 7
Warranty.....	8

TECHNICAL DATA

Pressure Ratio.....	1:1
Air Pressure Operating Range.....	45-150 psi
Maximum Fluid Working Pressure.....	150 psi
Delivery per minute*.....	10.6 gpm
Air Inlet Port Size.....	1/4" NPTF
Fluid Inlet Port Size (Stub only).....	1" NPTF
Fluid Outlet Port Size.....	3/4" NPTF
Wetted Parts.....	Steel, Brass, Aluminum, Polyurethane, and Buna-N

*Motor oil SAE 10-30 @ 68°F, air pressure 150 psi and free flow.

PRODUCT DESCRIPTION

The Lynx 1:1 pump is designed to deliver a range of light weight oils including gear oils. Available in both drum length and stub versions, the pump's 2" bung adapter allows installation directly onto original containers (drums) or bulk tank. The Lynx stub pump accepts a variety of different length and types of extension and/or suction tubes.

A pump's ability to deliver oil is based on the pressure (bar/psi) and quantity of air supplied to the air motor and the amount of material discharge (back) pressure to be overcome within the system.

DIMENSIONS

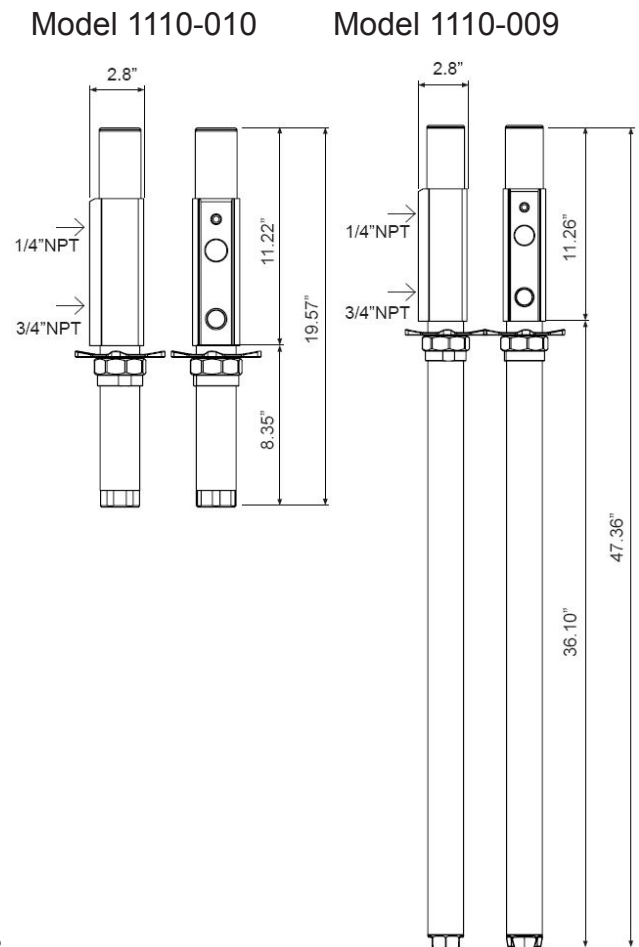

SAFETY

- The pump is intended for non-corrosive and petroleum based liquids. It may NOT be used for other purposes or for pumping gasoline, or other explosive liquids.
 - Check that all components used are suitable for the operating pressure of the system.
 - Do not use higher pressure than required for the satisfactory functioning of the system.
 - Before work is undertaken on the pump the compressed air should be disconnected from the pump and the whole system should then be depressurized.
 - Check all components thoroughly for damage and leakage.
 - Ensure that the compressed air is disconnected from the pump and the system is depressurized when system is not in use (i.e. overnight or during longer shut down periods) as there is always a risk of hoses bursting or pipework leaking etc.
6. Fit and secure the air inlet hose, slowly increase the air pressure letting the pump slowly build up fluid pressure.
 7. Ensure there are no leaks either on the air inlet or at the fluid outlet. To obtain maximum vacuum all connections should be sealed and tight.
 8. Slowly increase the air pressure to optimum working pressure.



WARNING

The maximum permitted air pressure is 150 psi, do not exceed this limit. Service: Before any servicework is carried out the compressed air must be turned off to the pump or the air coupling disconnected. The fluid outlet must be depressurized completely. Follow pressure relief procedure.

GENERAL

The pump is made up of two main parts: A compressed air operated two way piston air motor and a double acting liquid pump. The liquid is sucked into the pump tube via the bottom valve. When the piston moves upwards liquid is forced out of the fluid outlet. The fluid is forced out of the pump when the piston is moving in both directions. The relationship between the air piston and the pump piston determines the ratio of the pump. If the pump ratio is 3:1 the theoretical fluid pressure will be 3 times to the air pressure, when the pump stalls out. The air is exhausted from the pump via a sound attenuator.

INSTALLATION / OPERATION

1. To achieve long pump life we recommend that filter regulator to be installed prior to the air inlet of the pump.
2. Remove the protective packaging from the pump and also the protective plugs.
3. Fit the 2" pump adaptor firmly on to the barrel.
4. Mount the pump into the pump adaptor and lock into position.
5. Fit and secure the outlet hose.

MAINTENANCE

1. Before any service work is carried out the compressed air must be turned off to the pump or the air coupling disconnected. The fluid outlet must be depressurized completely.
2. Clean the air filter, remove all pollutants including condensed water.
3. Check system for any air or fluid leaks.
4. Always keep the equipment clean and remove foreign objects, ensure no pollutants enter the barrel as these will be pumped into the system.
5. When changing the barrel make sure the pump remains clean (Do not put on to floor otherwise the oil will become polluted).
6. When depressurizing the system or removing the outlet hose from the pump ensure there is a container available to drain the excess fluid into.

SERVICE

1. For your personal safety ensure the air is disconnected from the pump and the fluid discharge is depressurized before any service is carried out. Be cautious when repressurizing the system after any service work is carried out.
2. During service procedures it is important to avoid any scratching or any other damage to gasket or bearings surfaces. Keep tools and benches clean. Be extremely cautious when assembling or dismantling V-pack ings and O-rings. Exchange all worn or damaged parts no matter how slightly damaged they seem.
3. Clean and grease all gasket, bearing surfaces including O-rings and gaskets with teflon grease when reassembling pump.
4. Try to use paraffin to clean pump parts. If water based cleaners are used, wipe parts clean & dry immediately to avoid corrosion.

TROUBLESHOOTING

SYMPTOM	POSSIBLE CAUSE	REMEDY
The pump is not working or there is no oil delivery	<ol style="list-style-type: none"> 1. Not enough air pressure 2. Some outlet line component is clogged or closed 	<ol style="list-style-type: none"> 1. Increase the air pressure 2. Clean or open the outlet circuit
The pump begins to operate very fast without delivering oil	<ol style="list-style-type: none"> 1. The drum is empty 2. Oil level is beneath the suction tube inlet 	<ol style="list-style-type: none"> 1. Replace the drum 2. Lower the suction tube
The pump keeps on operating although the oil outlet is closed	<ol style="list-style-type: none"> 1. There is an oil leakage in some point of the outlet circuit 2. Contamination in the upper valve (27) or foot valve (35) 	<ol style="list-style-type: none"> 1. Verify and tighten or repair 2. Disassemble and clean, replace if damaged
Oil leaks out through the air outlet muffler (14).	Oil has by-passed to the air motor caused by worn or damaged packing set	Replace the fluid packing set
Air leaks out through the air outlet muffler (14).	<ol style="list-style-type: none"> 1. The air piston o-ring is worn or damaged (4). 2. The air motor cylinder is scratched (3). 3. The upper part of the central bar is damaged or scratched (6). 4. The air valve mechanism is worn or damaged (5). 	<ol style="list-style-type: none"> 1. Disassemble and clean, replace 2. Replace the air motor cylinder 3. Replace the central bar 4. Replace air valve mechanism
Decrease of the oil delivery	Contamination in the upper valve (27) or foot valve (35)	Disassemble and clean, replace if damaged

Parts List

Gen 1 - Lynx 1:1 Pump (made in Sweden⁽¹⁾)

Description	Item Number(s)	Repair Kits
Packing kit	4, 8, 9, 10, 16, 17, 18, 20, 26, 29	** Packing Kit - 832928
Air-valve	4, 5, 8	* Air Valve Kit - 832865
Central bar	6, 7, 8, 9, 10, 16, 17, 18, 20, 29	NOTE: The kits listed above and the bung adapter below are the only parts available for this pump.
Air cylinder	1, 2, 3, 8	
Piston kit	23, 24, 25, 26, 27, 28, 29	
Foot valve	31, 32, 33, 34, 35	
Pump tube	29, 30	
Piston rod	20, 21, 22, 23, 24, 25, 26, 27, 28, 29	
Air filter kit	11, 12, 13, 14	
Bung adapter	19	4411-021

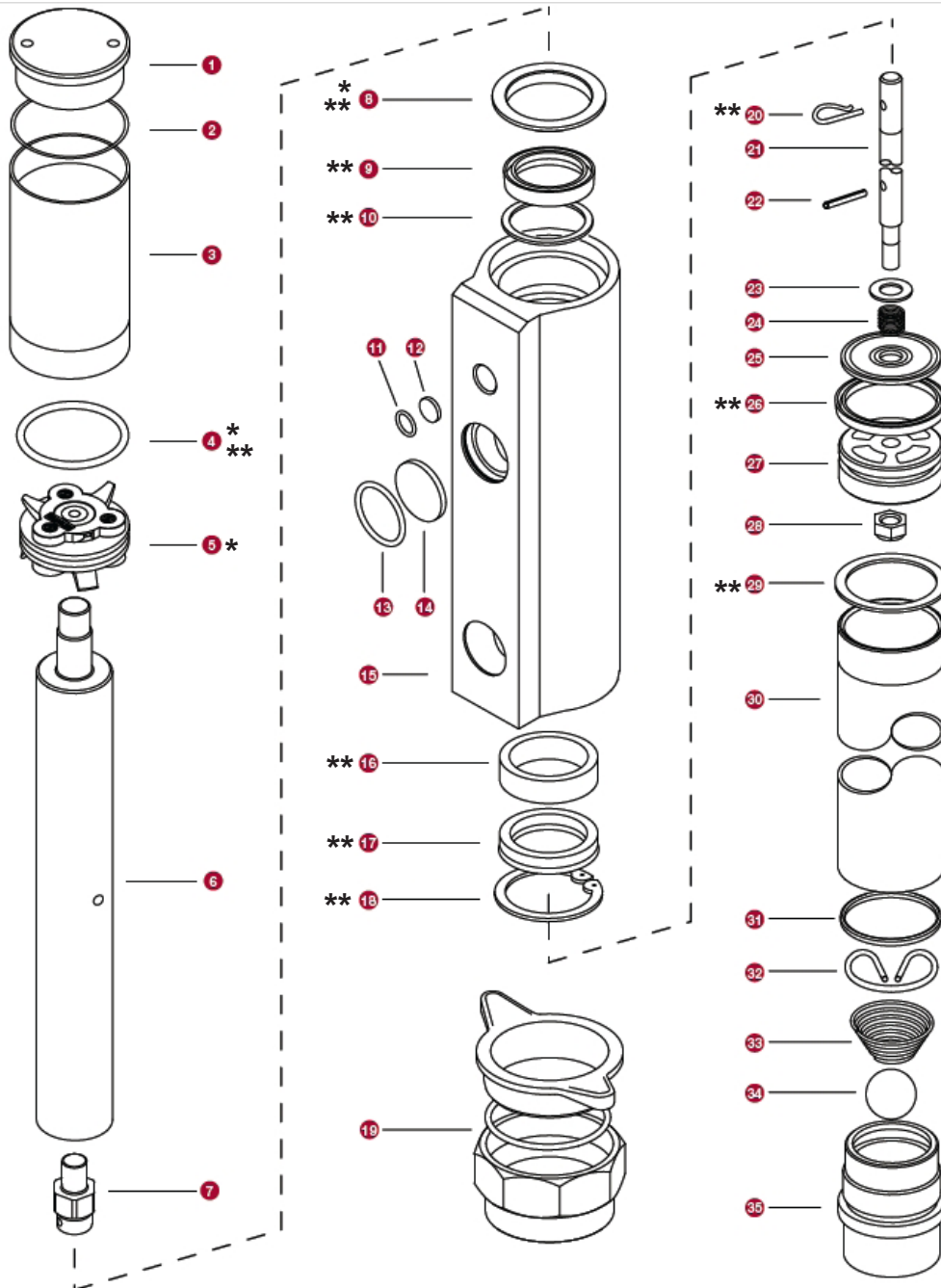

* Included in 832865 repair kit
 ** Included in 832928 repair kit

Parts List

Gen 2 - Lynx 1:1 Pump (made in EU⁽¹⁾)

Description	Item Number(s)	Repair Kits
Packing kit	4, 13, 14, 15, 16, 22, 23, 24, 31, 34	** Packing Kit - 833109
Air-valve	4, 5, 6, 7, 8, 9, 10, 14	* Air Valve Kit - 833110
Central bar	12, 13, 14, 15, 16, 22, 23, 24, 34	NOTE: The kits listed above and the bung adapter below are the only parts available for this pump.
Air cylinder	1, 2, 3, 14	
Piston kit	29, 31, 32, 33, 34	
Foot valve (Drum Length)	41, 42, 43, 44	
Foot valve (Stub)	36, 37, 38, 39, 40	
Pump tube (Drum Length)	34, 35A	
Pump tube (Stub)	34, 35B	
Piston rod (Drum Length)	13, 28A, 29, 30, 31, 32, 33, 34	
Piston rod (Stub)	13, 28B, 29, 30, 31, 32, 33, 34	
Air filter kit	17, 18, 19, 20	
Bung adapter	25, 26, 27	

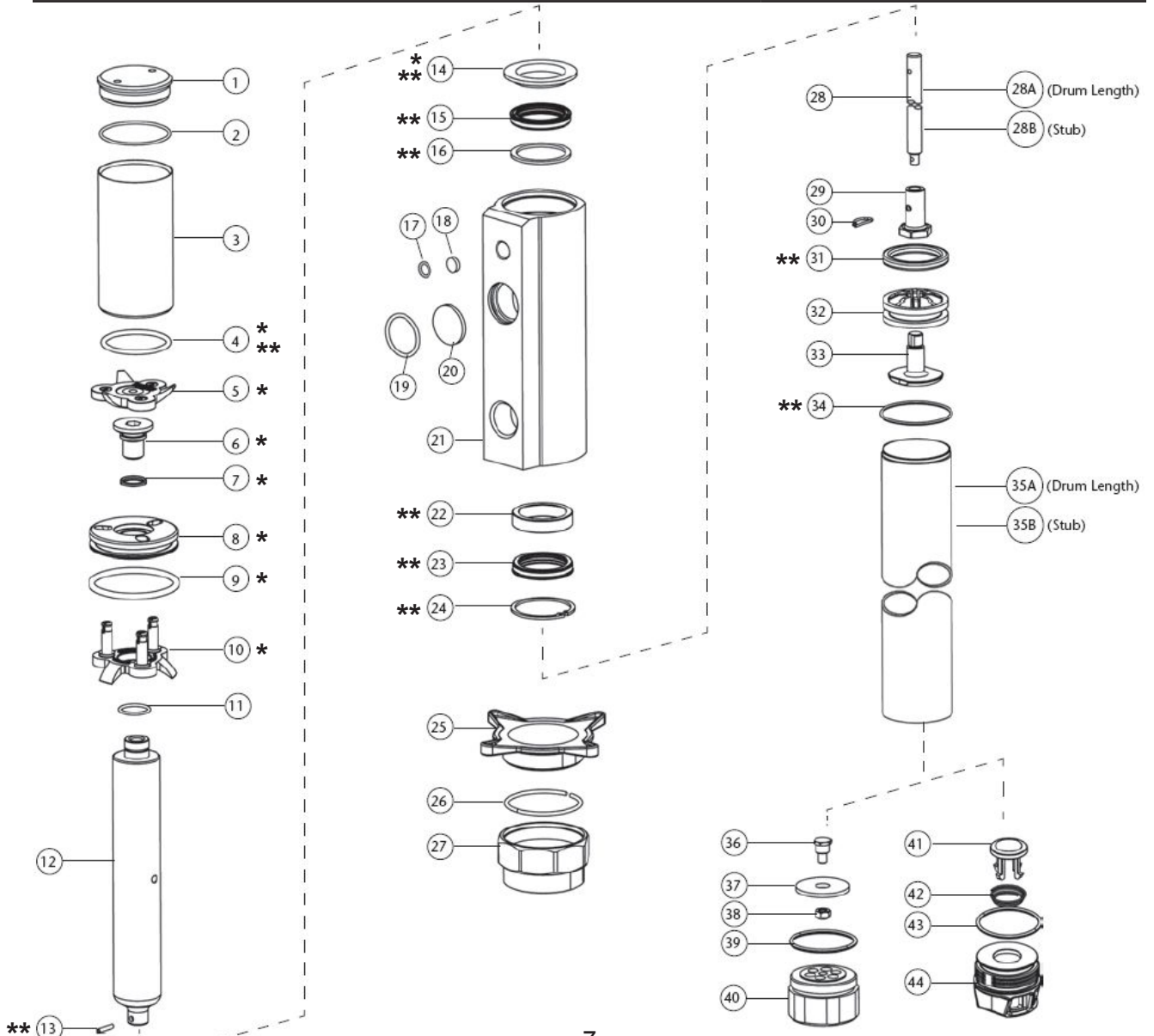

* Included in 833110 repair kit
 ** Included in 833109 repair kit

**For Warranty Information Visit:
www.balcrank.com**

Balcrank® Corporation
115 Reems Creek Road
Weaverville, NC 28787
800-747-5300
800-763-0840 Fax
www.balcrank.com

Revision Log:

Rev. A - New release
Rev. B - Added model 1110-010 (stub pump)
Rev. C - Added parts list & diagram for Gen 2
Lynx 1:1

SERVICE BULLETIN SB1102
Revision C 05/12