



Balcrank

Diesel Exhaust Fluid (DEF)

Automotive | Commercial | Industrial

Closed Systems Drum Packages Electric Diaphragm Pump



Features

- Compact design mounting bracket
- Heavy-duty cart - easily holds and rolls up to 55 gallon drum
- Large semi-pneumatic tires - allow for easy maneuvering of cart
- Large non-marking rear caster - built in break for safe and secure dispensing

Includes:

- 8570-006 6' x 3/4" Suction hose
- 8561-012 12' x 3/4" Discharge hose
- 4530-054 Drip tray
- 4320-014 Drum cart 55 gal for DEF
- 4530-065 Side mount bracket

Options:

- 3120-116 Meter DR style for DEF
- 1200-020 120 V AC Electric diaphragm pump
- 1200-021 12 V DC Electric diaphragm pump
- 3340-012 Auto nozzle, stainless steel
- 3340-015 Manual nozzle, polyethylene

Pump includes automatic shutoff.

Pump is UL approved

TECHNICAL DATA

	DATA 120 V AC (1200-020)	DATA 12 V DC (1200-021)
Max. Free Flow	8.5 GPM	9.5 GPM
Working Pressure	23 psi (1.6 bar)	23 psi (1.6 bar)
Power	120 V AC	12 V DC
Wetted Materials (pump)	Stainless Steel, Viton, PPE	Stainless Steel, Viton, PPE
Service Bulletin	SB 1129	SB 1130

MODELS AVAILABLE	DESCRIPTION
1210-046P	120 V AC Non-metered, Manual Nozzle
1210-048P	120 V AC Non-metered, Auto Nozzle
1210-049P	120 V AC Metered, Auto Nozzle
1210-053P	12 V DC Metered, Auto Nozzle

CLOSED system containers have a valve coupling system that seals the container opening on drums and totes (IBC) to prevent dirt, debris, bugs, etc., from entering the container and contaminating the diesel exhaust fluid. Liquid in container system is sealed and secure, throughout container life cycle.

DEF Packages do not include coupler systems. Order Separately.

You must choose a coupler kit to create a complete system for your distribution needs.

For closed systems, use Reusable Poly Valve (RPV) or Reusable Stainless Valve (RSV) systems accessories. RSV and RPV components are interchangeable.

Closed Systems Tote Packages Electric Diaphragm Pump



Features

- Compact design mounting bracket

Includes

- 8570-006 6' x 3/4" Suction hose
- 8561-020 20' x 3/4" Discharge hose
- 4530-054 Drip tray
- 4530-065 Side mount bracket

Options

- 3120-116 Meter DR style for DEF
- 1200-020 120 V AC Electric diaphragm pump
- 1200-021 12 V DC Electric diaphragm pump
- 3340-012 Auto nozzle, stainless steel
- 3340-015 Manual nozzle, polyethylene

Pump includes automatic shutoff.

Pump is UL approved

TECHNICAL DATA		
	DATA 120 V AC (1200-020)	DATA 12 V DC (1200-021)
Max. Free Flow	8.5 gal/min (32.18 l/min)	9.5 gal/min (34.07 l/min)
Working Pressure	23 psi (1.6 bar)	23 psi (1.6 bar)
Power	120 V AC	12 V DC
Wetted Materials (pump)	Stainless Steel, Viton, PPE	Stainless Steel, Viton, PPE
Service Bulletin	SB 1129	SB 1130

MODELS AVAILABLE	DESCRIPTION
1210-046	120 V AC Non-metered, Manual Nozzle
1210-047	120 V AC Metered, Manual Nozzle
1210-048	120 V AC Non-metered, Auto Nozzle
1210-049	120 V AC Metered, Auto Nozzle
1210-050	12 V DC Non-metered, Manual Nozzle
1210-052	12 V DC Non-metered, Auto Nozzle
1210-053	12 V DC Metered, Auto Nozzle



CLOSED system containers have a valve coupling system that seals the container opening on drums and totes (IBC) to prevent dirt, debris, bugs, etc., from entering the container and contaminating the diesel exhaust fluid. Liquid in container system is sealed and secure, throughout container life cycle.

DEF Packages do not include coupler systems. Order Separately.

You must choose a coupler kit to create a complete system for your distribution needs.

For closed systems, use Reusable Poly Valve (RPV) or Reusable Stainless Valve (RSV) systems accessories. RSV and RPV components are interchangeable.

Closed Systems Drum Packages CF Diaphragm Pump



Features

- Compact design mounting bracket
- Heavy-duty cart - easily holds and rolls up to 55 gallon drum
- Large semi-pneumatic tires - allows for easy maneuvering of cart
- Large non-marking rear caster - built in break for safe and secure dispensing

Includes

- 1120-025A CF15 AODD Pump for DEF
- 8570-006 6' x 3/4" suction hose
- 8561-012 12' x 3/4" discharge hose
- 4530-054 Drip tray
- 4320-014 Drum cart 55 Gal for DEF
- 4530-065 Side mount bracket
- 3260-060 Filter Reg 1/4" auto drain, mini

Options

- 3120-116 Meter DR style for DEF
- 3340-012 Auto nozzle, stainless steel

MODELS AVAILABLE	DESCRIPTION
1210-054P	CF15 Non-metered, Manual Nozzle
1210-055P	CF15 Metered, Manual Nozzle
1210-056P	CF15 Non-metered, Auto Nozzle
1210-057P	CF15 Metered, Auto Nozzle

TECHNICAL DATA

Air inlet	3/8" NPSM(F)
Fluid inlet port	1/2" BSPP(F) DEF
Fluid outlet port	1/2" BSPP(F) DEF
Max. Free Flow	14 gal/min (50 l/min)
Air pressure range	45-100 psi (3-7 bar)
Solids in suspension	1/8" (3 mm)
Wetted Materials	PTFE (Teflon), Viton®, Polypropylene, Stainless Steel, Hytrel®
Recommended fluids	Diesel exhaust fluid
Recommended Applications	Fluid dispensing, transfer, evacuation and distribution systems
Service Bulletin	SB 1122

CLOSED system containers have a valve coupling system that seals the container opening on drums and totes (IBC) to prevent dirt, debris, bugs, etc., from entering the container and contaminating the diesel exhaust fluid. Liquid in container system is sealed and secure, throughout container life cycle.

Note: Pump packages include all hoses and adapters required for connecting a DEF pump to the air supply and DEF dispense line.

DEF Packages do not include coupler systems.

You must choose a coupler kit to create a complete system for your distribution needs.

For closed systems, use Reusable Poly Valve (RPV) or Reusable Stainless Valve (RSV) systems accessories. RSV and RPV components are interchangeable.

Closed Systems Tote Packages CF Diaphragm Pump



Features

- Compact design mounting bracket
- Includes**
- 1120-025A CF15 AODD Pump for DEF
- 8570-006 6' x 3/4" Suction hose
- 8561-020 20' x 3/4" Discharge hose
- 4530-054 Drip tray
- 4530-065 Side mount bracket
- 3260-060 Reg 1/4" auto drain, mini
- Options**
- 3120-116 Meter DR style for DEF
- 3340-018 Manual nozzle, polyethylene- BSPP

Pump includes automatic shutoff.
Pump is UL approved

MODELS AVAILABLE	DESCRIPTION
1210-054	CF15 Non-metered, Manual Nozzle
1210-055	CF15 Metered, Manual Nozzle
1210-056	CF15 Non-metered, Auto Nozzle
1210-057	CF15 Metered, Auto Nozzle

TECHNICAL DATA	
Air inlet	3/8" NPSM(F)
Fluid inlet port	1/2" BSPP(F) DEF
Fluid outlet port	1/2" BSPP(F) DEF
Max. Free Flow	14 gal/min (50 l/min)
Air pressure range	45-100 psi (3-7 bar)
Solids in suspension	1/8" (3 mm)
Wetted Materials	PTFE (Teflon), Viton, Polypropylene, Stainless Steel, Hytrel
Recommended fluids	Diesel exhaust fluid
Recommended Applications	Fluid dispensing, transfer, evacuation and distribution systems
Service Bulletin	SB 1122

CLOSED system containers have a valve coupling system that seals the container opening on drums and totes (IBC) to prevent dirt, debris, bugs, etc., from entering the container and contaminating the diesel exhaust fluid. Liquid in container system is sealed and secure, throughout container life cycle.

Note: Pump packages include all hoses and adapters required for connecting a DEF pump to the air supply and DEF dispense line.

DEF Packages do not include coupler systems.

You must choose a coupler kit to create a complete system for your fluid distribution needs.

For closed systems, use Reusable Poly Valve (RPV) or Reusable Stainless Valve (RSV) systems accessories. RSV and RPV components are interchangeable.

System Components Electric and AODD Pumps



MODELS AVAILABLE	DESCRIPTION
1200-020	120 V AC Diaphragm pump, UL auto shut-off
1200-021	12 V DC Diaphragm pump, UL auto shut-off



MODELS AVAILABLE	DESCRIPTION
1120-034	CF10 Diaphragm pump
1120-025A	CF15 Diaphragm pump
1120-031A	CF30 Diaphragm pump

6

TECHNICAL DATA 120 V AC 1200-020 120 V AC Diaphragm pump	
Fluid inlet port	3/4" BSPP(M)
Fluid outlet port	3/4" BSPP(M)
Flow Rate	8.5 gal/min (32.18 l/min)
Working Pressure	23 psi (1.6 bar)
Power	120 V AC, UL approved
Wetted Materials	Stainless Steel, Viton®, PPE
Service Bulletin	SB 1129

TECHNICAL DATA 12 V DC 1200-021 12 V DC Diaphragm pump	
Fluid inlet port	3/4" BSPP(M)
Fluid outlet port	3/4" BSPP(M)
Flow Rate	9.5 gal/min (34.07 l/min)
Working Pressure	23 psi (1.6 bar)
Power	12 V DC, UL approved
Wetted Materials	Stainless Steel, Viton®, PPE
Service Bulletin	SB 1130

TECHNICAL DATA CF10 - CF15 Diaphragm pump		
	1120-034 CF10	1120-025A CF15
Air inlet	3/8" NPSM (F)	1/2" BSPP(F)
Fluid inlet port	1/2" BSPP(F) DEF	1/2" BSPP(F) DEF
Fluid outlet port	1/2" BSPP(F) DEF	1/2" BSPP(F) DEF
Max. Free Flow	10 gal/min (38 l/min)	14 gal/min (50 l/min)
Air pressure range	22 to 102 psi (1.5 to 7 bar)	22 to 102 psi (1.5 to 7 bar)
Solids in suspension	1/8" (3 mm)	1/8" (3 mm)
Wetted Materials	PTFE (Teflon), Viton®, Polypropylene, Stainless Steel, Acetal, and Hytrel®	PTFE (Teflon), Viton®, Polypropylene, Stainless Steel, Hytrel®
Service Bulletin	SB 1121	SB 1122

TECHNICAL DATA CF30 Diaphragm pump	
	1120-031A CF30
Air inlet	3/8" NPSM(F)
Fluid inlet port	1" BSPP(F) DEF
Fluid outlet port	1" BSPP(F) DEF
Max. Free Flow	28 gal/min (100 l/min)
Air pressure range	22 to 102 psi (1.5 to 7 bar)
Solids in suspension	3/16" (4 mm)
Wetted Materials	PTFE (Teflon), Viton®, Polypropylene, Stainless Steel, and Hytrel®
Service Bulletin	SB 1124

Hose Reels Extended Volume (EV)



DEF

The EV reel is for longer hose lengths and higher flow requirements. Includes hose, hose stop and a 2.5' connecting hose.

MODELS AVAILABLE	DESCRIPTION	REPLACEMENT HOSE
EXTENDED VOLUME (EV) DEF (Diesel Exhaust Fluid) Low pressure 150 psi (10 bar) for delivery of DEF		
2400-010	Bare reel, up to 50' x 3/4" ID hose BSPP	-
2400-011	50' x 3/4" ID BSPP includes 3' inlet hose	8569-050

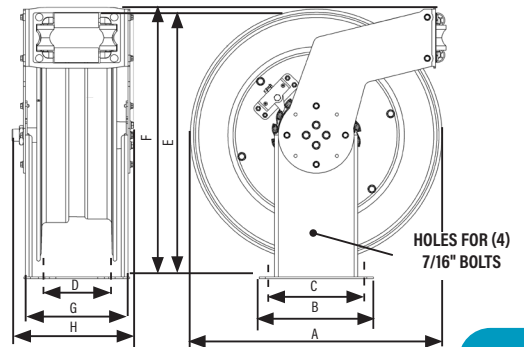





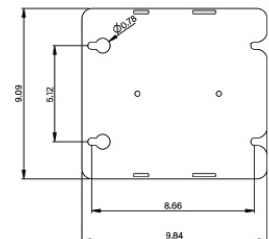





TECHNICAL DATA	
Fluid inlet port	3/4" BSPP cone seal bare
Fluid outlet port	3/4" BSPP bare
Inlet/Outlet thread	3/4" BSPP for 3/4" hoses
Wetted Materials	Stainless steel, Polypropylene and Viton*
Service Bulletin	SB 2028

DIMENSIONS SERIES (INCHES)							
A	B	C	D	E	F	G	H
22"	85/8"	5"	51/8"	22"	23/2"	9"	91/4"



System Components Meters and Nozzles

METERS AND SOLENOIDS						
	MODEL	DESCRIPTION	INLET/OUTLET PORT	FLOW RATE	OPERATING PRESSURE	POWER
	3120-116	DR Style Meter for DEF	1/2" BSPP(F/F) & flange	0.25 - 13.2 gal/min (1 - 50 l/min)	435 psi (30 bar)	2 x 1.5 V alkaline batteries size "AAA"
	3120-119	DEF Turbine Meter	1" BSPP(M/M)	1.3-26.4 gal/min (4.92-99.94 l/min)	145 psi (10 bar)	2 x 1.5 V alkaline batteries size "AAA"
	3120-206	Turbine Meter, pulse-out	1" BSPP(F/F)	83 PPQ	145 psi (10 bar)	24 V AC
	3120-207	Solenoid	3/4" NPT(F/F)	8.4 gal/min (32.71 l/min)	150 psi (10 bar)	24 V AC





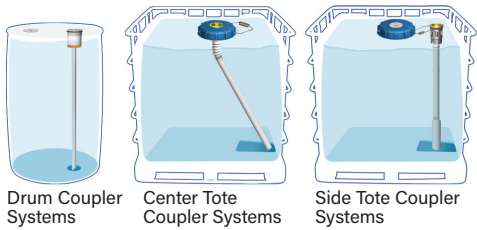

















NOZZLES	
MODEL	DESCRIPTION
	3340-011 Nozzle, manual Polyethylene 3/4" barb (M)
	3340-018 Nozzle, manual Polyethylene 3/4" BSPP(F)
	3340-015 Nozzle, manual Polyethylene 1" barb (M)
	3340-012 Nozzle, automatic shut-off Stainless steel, 3/4" BSPP(F)
	3340-017 Nozzle, Magnetic, 3/4" BSPP(F)
	4530-054 Nozzle holder, drip tray

Coupler Components and Kits

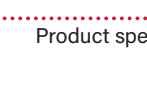

NOTE: When ordering suction kits ensure you have selected the correct dip tube orientation for your system. DEF Packages do not include coupler systems. You must choose a coupler kit to create a complete system for your fluid distribution needs.

OPEN SYSTEMS COMPONENTS		
For open systems, use Drum Quick Pro (DQP) accessories.		
DRUM QUICK PRO (DQP)		
	4530-001	Coupler, polyethylene 3/4" barb
	3250-002	Replacement filter, air - used on 4530-001
	4530-002	Insert, polyethylene, 2" ABUT (American Buttress)
	4530-003	Key - DQP series
	4530-006	Dip tube, 55 gal drum mount length
	4530-005	Dip tube, 275 gal tote mount length
	4530-004	Dip tube, 330 gal tote mount length
SUCTION KITS		
	4530-007	Suction Kit, DQP series Includes: coupler, insert, key and 55 gal drum mount length dip tube
	4530-008	Suction Kit, DQP series Includes: coupler, insert, key and 275 gal tote mount length dip tube
	4530-009	Suction Kit, DQP series Includes: coupler, insert, key and 330 gal tote mount length dip tube

CLOSED SYSTEMS		
For closed systems, use Reusable Poly Valve (RPV) or Reusable Stainless Valve (RSV) systems accessories. RSV and RPV components are interchangeable		
REUSABLE STAINLESS VALVE (RSV)		
4 Prong, Green Seal - Preferred and Balcrank recommended		
	4530-036	Coupler, Stainless Steel 3/4" barb. For use with 4530-037 only
	4530-048	Coupler, Fill head 1" NPT(M) For use with 4530-037 only
	4530-037	Insert, stainless steel, 2" ABUT (American Buttress)
	4530-038	Key, stainless steel, RSV/RPV
REUSABLE POLY VALVE (RPV)		
	4530-057	Coupler, RSV/RPV, Poly - 3/4" barb
	4530-063	Insert, polyethylene, 2" ABUT (American Buttress) (M)
	4530-058	Key - Poly, RSV/RPV
RSV/RPV DIP TUBES		
	4530-041	Dip tube, 55 gal drum mount length
	4530-044	Dip tube, 275 gal tote - center mount length
	4530-040	Dip tube, 275 gal tote - side mount length
	4530-043	Dip tube, 330 gal tote - center mount length
	4530-039	Dip tube, 330 gal tote - side mount length
SUCTION KITS		
	4530-042	Suction Kit, RSV series - includes: coupler 4530-036, insert and 55 gal drum mount length dip tube
	4530-045	Suction Kit, RSV series - includes: coupler 4530-036, insert 2- 275 gal tote mount length dip tube
	4530-046	Suction Kit, RSV series - includes: coupler 4530-036, insert and 2- 330 gal tote mount length dip tube
	4610-001	Suction Kit, RSV/RPV SS series - includes: coupler 4530-036, DEF Hose 6' x 3/4" ID, Fitting 1" BSP(F) x 3/4" barb
	4530-059	Suction Kit, RPV Poly series - includes: coupler 4530-057, insert and 55 gal drum dip mount length tube
	4530-060	Suction Kit, RPV Poly series - includes: coupler 4530-057, insert and 2-275 gal tote mount length dip tube
	4530-061	Suction Kit, RPV Poly series - includes: coupler 4530-057, insert and 2- 330 gal tote mount length dip tube
	4610-003	Suction Kit, RPV Poly series - includes: coupler 4530-057, DEF Hose 6' x 3/4" ID, Fitting 1" BSP(F) x 3/4" barb
COUPLER KIT ACCESSORIES		
	4530-066	Center cap, tote 6" diameter x 2.5" ID ABUT (American Buttress)
	6210-001	Funnel with spout. 1 pt. 1/2" spout

System Components

Hand Pump, Hoses, and Hose Accessories



MODELS AVAILABLE	DESCRIPTION
1300-028	Hand Pump, Manual lever

TECHNICAL DATA	
All polypropylene construction, includes a 2" bung adaptor	
Delivery Volume	1 pint per stroke (500 cc)
Temp Range	23 °F to 113 °F (-5 °C to 45 °C)
Wetted Materials	Polypropylene, EPDM
Service Bulletin	SB 1117

HOSE - SUCTION - BEFORE PUMP



8570-003 3' x 3/4" ID Cut-end

8570-006 6' x 3/4" ID Cut-end

8572-006 6' x 1" ID Cut-end w/ hose clamps

HOSE - DISPENSE - AFTER PUMP

All hoses are specially formulated polyurethane unless otherwise stated



8551-006 6' x 1" ID w/hose clamps and simple spout

8560-003 3' x 3/4" ID w/hose clamps

8560-012 12' x 3/4" ID w/hose clamps

8562-003 3' x 3/4" ID Swivel 3/4" BSPP(M) - Straight 3/4" BSPP(M)

8569-016 16' x 3/4" ID Swivel 3/4" BSPP(M/M)

8569-020 20' x 3/4" ID Swivel 3/4" BSPP(M/M)

8569-030 30' x 3/4" ID Swivel 3/4" BSPP(M/M)

8569-050 50' x 3/4" ID Swivel 3/4" BSPP(M/M)

HOSE - DISPENSE - AFTER PUMP - CLAMP NOT INCLUDED

All hoses are specially formulated polyurethane unless otherwise stated



8561-003 3' x 3/4" ID Swivel 3/4" BSPP(M) cut end requires a hose clamp NOT included Order 2230-032

8561-006 6' x 3/4" ID Swivel 3/4" BSPP(M) cut end requires a hose clamp NOT included Order 2230-032

8561-012 12' x 3/4" ID Swivel 3/4" BSPP(M) cut end requires a hose clamp NOT included Order 2230-032

8561-016 16' x 3/4" ID Swivel 3/4" BSPP(M) cut end requires a hose clamp NOT included Order 2230-032

8561-020 20' x 3/4" ID Swivel 3/4" BSPP(M) cut end requires a hose clamp NOT included Order 2230-032

8561-030 30' x 3/4" ID Swivel 3/4" BSPP(M) cut end requires a hose clamp NOT included Order 2230-032

HOSE ACCESSORIES



2230-033 Hose bend restrictors - 12" black poly



2230-032 Stainless steel hose clamp 3/4"

System Accessories

ADAPTERS-ELBOW			SEALS		
	3270-162	Poly Hose elbow, 1" BSPP(M) to 3/4" barb		3270-171	3/4" Stainless steel /Viton' bonded seal
	3270-176	Poly Hose elbow, 1" NPT(M) to 3/4" barb		3270-169	1" Stainless steel /Viton' bonded seal
	3270-175	Stainless steel elbow, 1" BSPP(M) X 3/4" BSPP(F) 90 DEG			
ADAPTERS - HOSE BARB			FILTERS		
	3270-163	Poly Hose barb, 1" BSPP(M) to 3/4" barb		3250-001	Filter, in-line 10 micron - 3/4" NPT (filter included). For replacement filter use 832796
	3270-165	Poly Hose barb, 1" NPT(M) to 3/4" barb			
	3270-166	Poly Hose barb, 3/4" NPT(M) to 3/4" barb		3250-002	Replacement filter for 4530-001 in-line filter, 10 micron
	3270-177	Poly Hose barb, 1/2" NPT(M) to 3/4" barb			
	3270-164	Stainless steel swivel 3/4" BSPP(M) to 3/4" barb			
ADAPTERS - COUPLERS (F/F)			BRACKETS		
	3270-173	Poly coupler, 1" NPT(F) to 1" BSPP(F)		4530-064	CF AODD Pump Shelf For use with the 4530-065 side mount bracket. Use CF AODD pump shelf to attach the CF15 pump to the side mount bracket
	3270-167	Stainless steel coupler, 1" BSPP(F) to 1" BSPP(F)			
	3270-168	Poly coupler, reducer - 1" BSPP(F) to 3/4" BSPP(F)			4411-016
ADAPTERS - HEX NIPPLE					
	3270-172	Stainless steel Adapter, 1" BSPP(M) x 3/4" NPT(M)			
ADAPTERS - SWIVEL UNION			DOLLY BASES AND DRUM CARTS		
	3270-174	Stainless steel swivel, 1" BSPP(F) to 3/4" BSPP(M)		4320-014	Drum Cart, 55-gal heavy duty <ul style="list-style-type: none"> • Heavy-duty cart - easily holds and rolls up to 55 gallon drum • Large semi-pneumatic tires - Allows for easy maneuvering of cart • Large non-marking rear caster - built in break for safe and secure dispensing
	3270-161	Poly swivel, 1" BSPP(M) x 1" BSPP(F)			4310-004

Repair Kits for DEF Pumps

6

CF10		
PUMP MODELS	KIT NUMBER	DESCRIPTION
CF10 AODD PUMPS - 1120-034		
1120-034	833732	Air valve kit
1120-034	833207	Stroke sensor kit
1120-034	833208	Check Ball kit
1120-034	833735	Ball Seats, O-rings, ball guides
1120-034	833338	Diaphragms kit
1120-034	833332	Bushing, seal, push rod
CF15		
PUMP MODELS	KIT NUMBER	DESCRIPTION
CF15 AODD PUMPS - 1120-025A		
1120-025A	833372	Air valve kit
1120-025A	833207	Stroke sensor kit
1120-025A	833208	Check Ball kit
1120-025A	833735	Ball Seats, O-rings, ball guides
1120-025A	833210	Bushing, seal, push rod (Prior to 2/1/2013)
1120-025A	833332	Bushing, seal, push rod (After to 2/1/2013)
1120-025A	833211	Diaphragms kit (Prior to 2/1/2013)
1120-025A	833338	Diaphragms kit (After to 2/1/2013)
1120-025A	833341	Retrofit Kit (Updates pumps prior to 2/1/2013)
CF30		
PUMP MODELS	KIT NUMBER	DESCRIPTION
CF30 AODD PUMPS - 1120-031A		
1120-031A	833733	Air valve kit
1120-031A	833207	Stroke sensor kit
1120-031A	833233	Check Ball kit
1120-031A	833738	Ball Seats, O-rings, ball guides
1120-031A	833235	Bushing, seal, push rod (Prior to 2/1/2013)
1120-031A	833335	Bushing, seal, push rod (After to 2/1/2013)
1120-031A	833339	Diaphragms kit (After to 2/1/2013)
1120-031A	833342	Retrofit Kit (Updates pumps prior to 2/1/2013)
ELECTRIC DIAPHRAGM PUMPS		
PUMP MODELS	KIT NUMBER	DESCRIPTION
ALUMINUM AODD PUMPS - 1200-020 120V AC, 1200-021 120V DC		
1200-020, 1200-021	833415	Bypass valve kit
1200-020, 1200-021	833416	Pump head kit
1200-020, 1200-021	833417	Fan cover kit
1200-020	833418	Electric connection kit
1200-021	833419	Electric connection kit for 12V pump

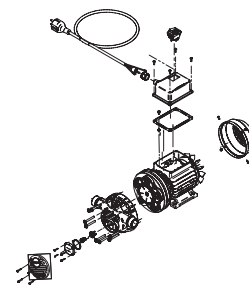
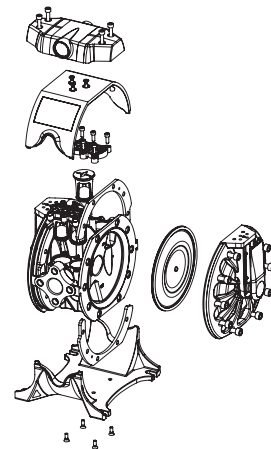
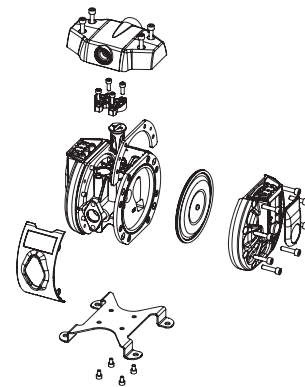
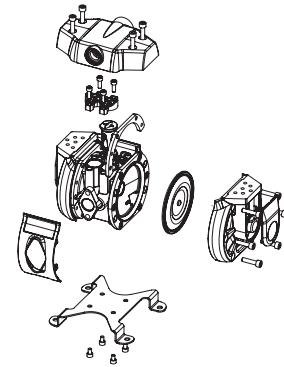

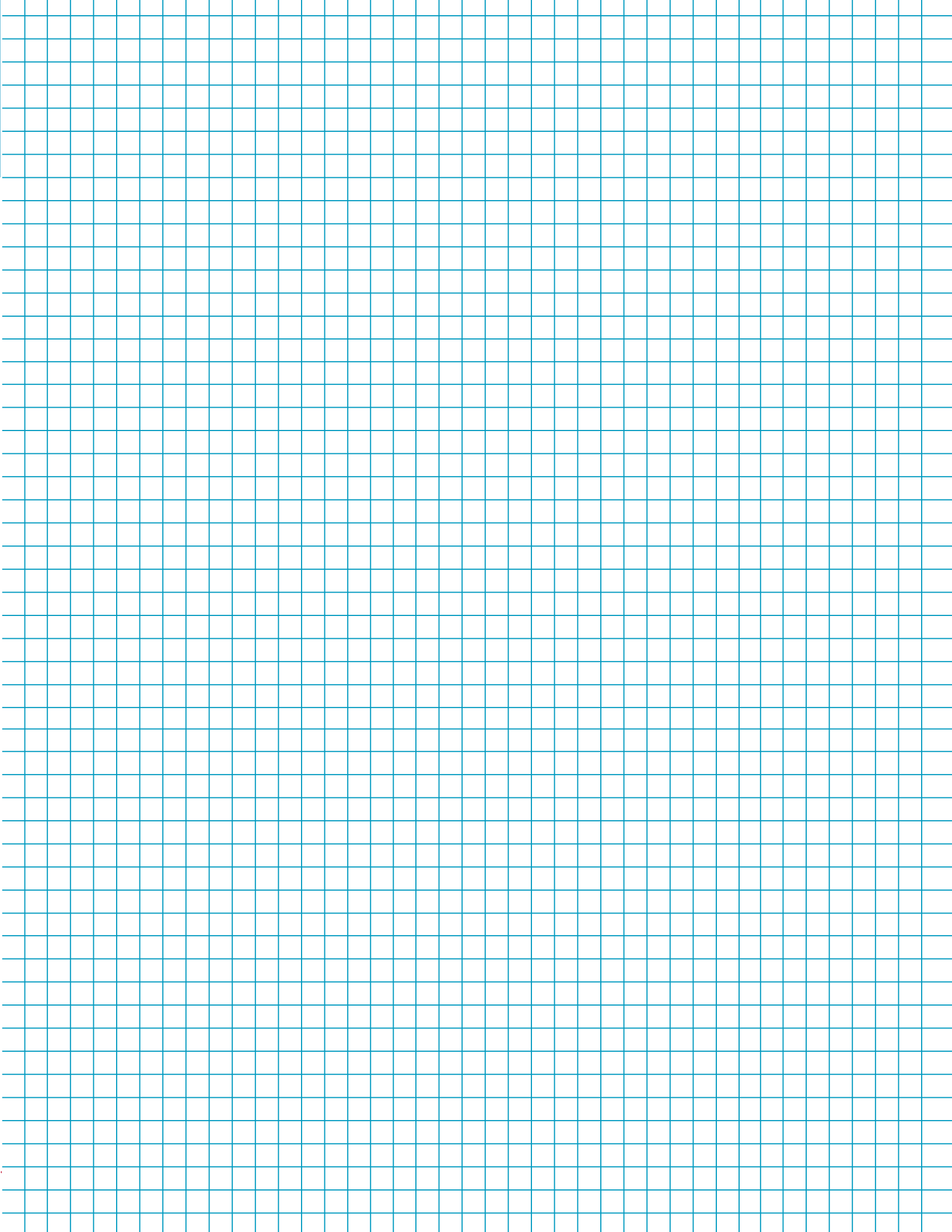

Balcrank

Fluid Dispensing Systems

Balcrank Corporation

90 Monticello Road
Weaverville, NC 28787, USA
Tel.: (800) 747-5300 or (828) 645-4261
Fax: (800) 763-0840 or (828) 658-0840
info@balcrank.com
www.balcrank.com
www.shopbalcrank.com

Customer Support

Tel.: (800) 747-5300 or (828) 645-4261
(Monday to Friday, 8:00 AM - 5:00 PM ET)

- Order entry
- Product availability and information
- Pricing
- Shipping dates and delivery information
- Return Merchandise Authorization

Technical Support

Tel.: (800) 747-5300 or (828) 645-4261
(Monday to Friday, 8:00 AM - 5:00 PM ET)

- Repair advice
- Product application recommendations
- Warranty claims and returns
- Service bulletins

Place an Order

Tel.: (800) 747-5300 or (828) 645-4261

Fax: (800) 763-0840 or (828) 658-0840

- Fax orders day or night
- Order confirmed next business day by fax or e-mail

E-mail: orders@balcrank.com

Online: www.shopbalcrank.com

- Place orders on-line 24/7
- Four convenient ways to shop
- Search by product name or number
- Browse the site and add to cart
- Copy past orders to create a duplicate order
- Rapid order entry
- Pricing is live and specific to your account
- Build, print, save, and manage quotes for access at a later date
- Track shipped orders
- Easy management of personnel access and assigned permissions

Distributor