

Balcrank

SERVICE BULLETIN SB 1059
Revised 7/07

1" UL LISTED PUMP Model 1120-015

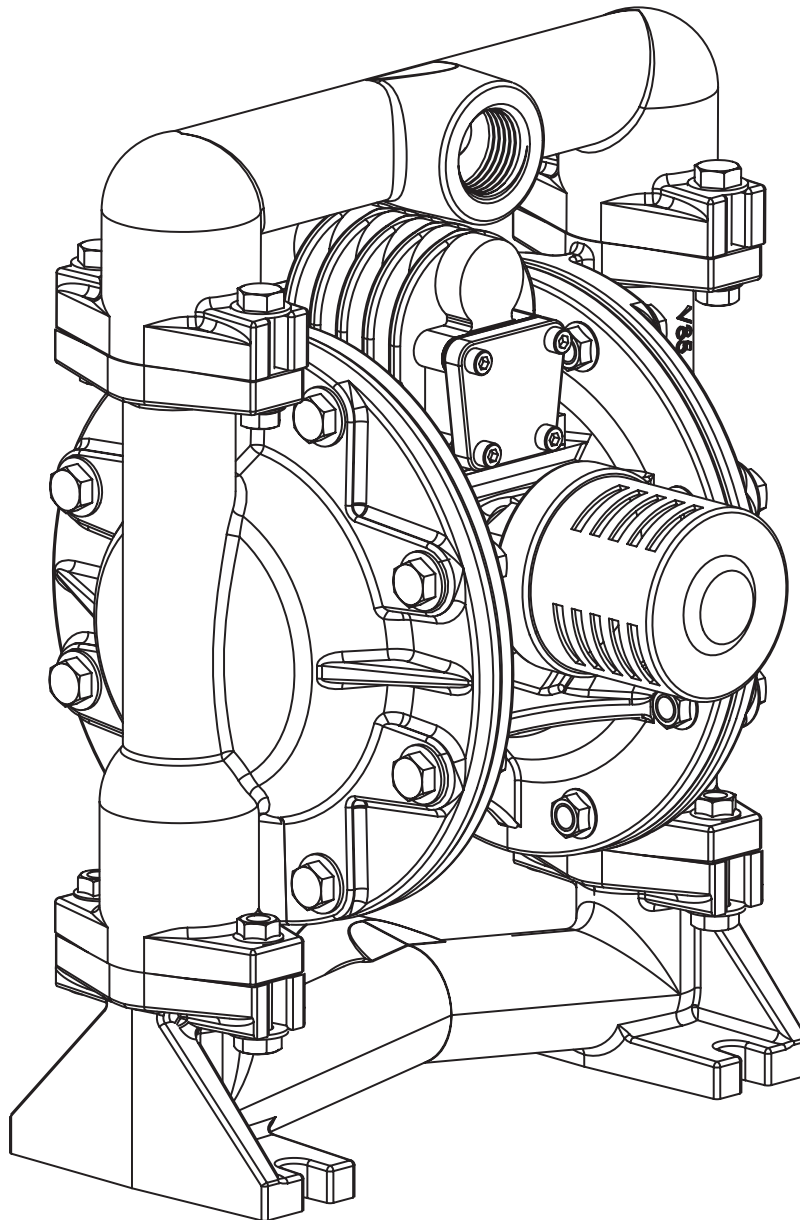

OPERATION, INSTALLATION, MAINTENANCE AND REPAIR GUIDE

Thoroughly read and understand this manual before installing, operating or servicing this equipment.

Important Safety Information

 **! IMPORTANT**

Read these safety warnings and instructions in this manual completely, before installation and start-up of the pump. It is the responsibility of the purchaser to retain this manual for reference. Failure to comply with the recommendations stated in this manual will damage the pump, and void factory warranty.

 **! WARNING**

This pump is pressurized internally with air pressure during operation. Always make certain that all bolting is in good condition and that all of the correct bolting is reinstalled during assembly.

 **! CAUTION**

Before pump operation, inspect all gasketed fasteners for looseness caused by gasket creep. Re-torque loose fasteners to prevent leakage. Follow recommended torques stated in this manual.

 **! WARNING**

When used for toxic or aggressive fluids, the pump should always be flushed clean prior to disassembly.

 **! WARNING**

Before maintenance or repair, shut off the compressed air line, bleed the pressure, and disconnect the air line from the pump. The discharge line may be pressurized and must be bled of its pressure.

 **! WARNING**

Before doing any maintenance on the pump, be certain all pressure is completely vented from the pump, suction, discharge, piping, and all other openings and connections. Be certain the air supply is locked out or made non-operational, so that it cannot be started while work is being done on the pump. Be certain that approved eye protection and protective clothing are worn all times in the vicinity of the pump. Failure to follow these recommendations may result in serious injury or death.

 **! WARNING**

In the event of diaphragm rupture, pumped material may enter the air end of the pump, and be discharged into the atmosphere. If pumping a product which is hazardous or toxic, the air exhaust must be piped to an appropriate area for safe disposition.

 **! WARNING**

Airborne particles and loud noise hazards. Wear ear and eye protection.

 **! WARNING**

In the presence of explosive vapors, take action to prevent static sparking. Failure to ground the pump, piping, valves, containers, or other miscellaneous equipment can result in fire or explosion. A green grounding lug is provided on the pump.

1120-015 1" UL Listed Pump Characteristics

Adjustable Flow Rate	0-35 gpm (0-132 lpm)
Pump Connections	
Inlet/Discharge	1" Female NPT
Air Inlet	3/8" NPTF
Air Exhaust	1/2" NPTF
Suction Lift	
	15' (4.57 m) dry 25' (7.62 m) wet
Maximum Particle Size	1/8" (3.2 mm) diameter
Shipping Weight	31 lbs. (14 kg)
Wetted Materials	
	Aluminum Buna-N PTFE

WARNING

Air Operated Diaphragm Pumps may generate fluid pressures equal to the air supply pressure.

CAUTION:
Do Not exceed 50 psig (3.4 bar)
air supply pressure.

1120-015 1" UL Listed Pump Specifications

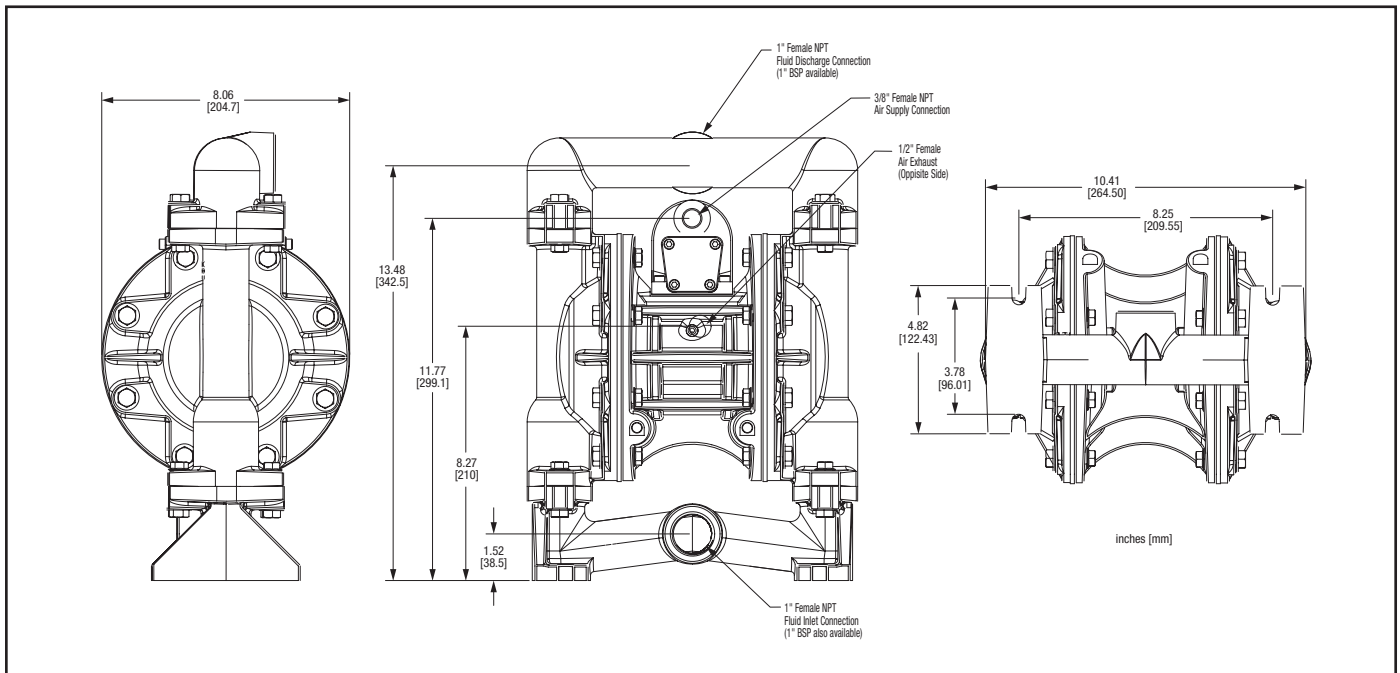

1120-015 UL Listed Pump

The 1120-015 UL pump model has been tested by Underwriters Laboratories, Inc. and is in compliance with the safety specifications for air-operated pumps for use in the transfer of flammable liquids. This pump has been rated for use in pumping the following liquids:

- Diesel Fuel
- Gear Oil
- Kerosene
- Motor oil
- Nos. 2 through 4 oil
- Water

Maximum rated air inlet pressure: 50 PSI
Maximum rated discharge pressure: 50 PSI

1120-015 1" UL Listed Pump Performance

Displacement Per Stroke, (Avg.), 0.10 Gal. (0.38 L)

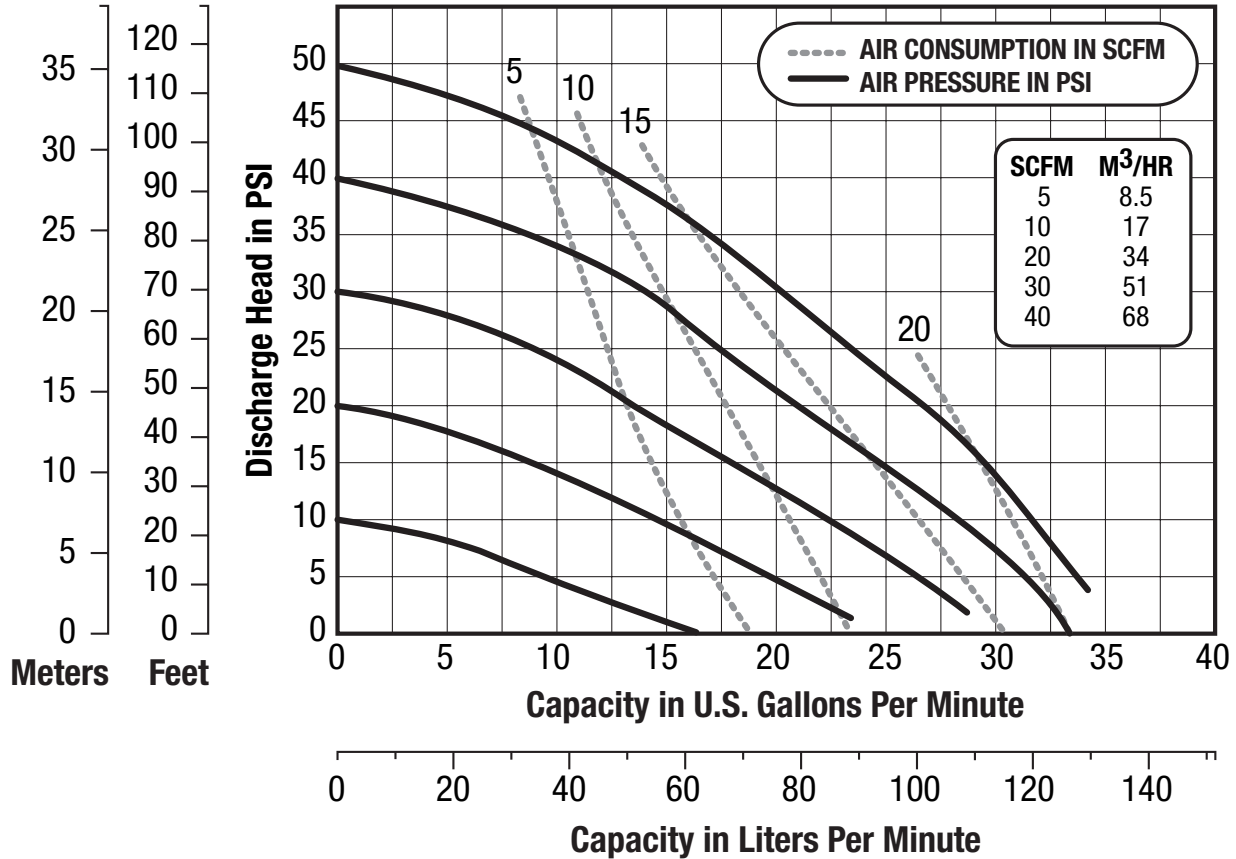

How To Read Pump Performance Curves

To find the air inlet pressure and air volume necessary to operate a pump at a desired flow rate and head pressure you need to first go to the flow chart on the left. Find the desired flow horizontally on the chart and move vertically until you intersect with the system discharge pressure. This point represents the necessary air supply pressure. Next, go to the corresponding chart on the right. Find the desired flow horizontally across the bottom of the chart and move vertically until you cross the necessary air supply pressure. Finally, move horizontally to the left to find the required air supply volume.

CAUTION: Do Not exceed 50 psig (3.4 bar) air supply pressure.

INSTALLATION

Check the tightness of the pump's hardware prior to installation and operation of a new pump. Pump hardware is prone to loosening due to vibration in transportation, expansion and contraction, or the relaxing of materials after they are torqued. **It is important that the pump is not under pressure when hardware is being tightened.**

1120-015 1" UL Listed Pump Torque Settings

Water Chamber Bolts	155 in-lbs (17.5 N-m)
Diaphragm Plates	10 ft-lbs (13.6 N-m)
Air Valve Screws	25 in-lbs (2.8 N-m)
Manifold Bolts	230 in-lbs (26.0 N-m)

This pump comes with a footed base for easy mounting in permanent installations. The pump should be mounted in a vertical position. In permanent installations, the pump should be attached to plant piping using a flexible coupling on both the intake and discharge connections to reduce vibration to the pump and piping. To further reduce vibration, a surge suppressor next to the pump may be used.

All pipe joints leading to the pump that are in contact with the fluid being pumped must be coated with a gas-resistant pipe compound. All UL listed pump installations shall be made in accordance with the Flammable and Combustible Liquids Code, NFPA 30A, as appropriate to the intended use of the pump.

Suction pipe size should be at least 1 inch in diameter or even larger if highly viscous fluid is to be pumped. If suction hose is used, it must be of a non-collapsible reinforced type. Discharge piping should be at least 1 inch in diameter. It is critical, especially on the suction side of the pump, that all fittings and connections are airtight or pumping efficiency will be reduced and priming will be difficult.

The air supply line should be at least 1/2 inch in diameter. Make certain the supply line and compressor are capable of supplying the required pressure and volume of air needed to operate the pump at the desired flow rate. The quality of the compressed air source should be considered. Air that is contaminated with moisture and dirt may result in erratic pump performance and increased maintenance cost as well as frequent process "down time" when the pump fails to operate properly.

PUMP OPERATION

The pump is powered by compressed air. Compressed air is directed to the pump air chamber by the main air valve. The compressed air is separated from the fluid by a membrane called a diaphragm. The diaphragm in turn

applies pressure on the fluid and forces it out of the pump discharge. While this is occurring, the opposite air chamber is depressurized and exhausted to atmosphere and fluid is drawn into the pump suction. The cycle again repeats, thus creating a constant reciprocating action, which maintains flow through the pump. The flow is always in through the bottom suction connection and out through the top discharge connection. Since the air pressure acts directly on the diaphragms, the pressure applied to the fluid roughly approximates the air supply pressure supplied to the main valve.

TROUBLESHOOTING

The pump will not run, or runs slowly:

1. Examine the air inlet for debris.
2. Check for a sticking air valve. Remove the air valve from the pump and check to see if air valve spool can move freely. If dirt or debris is present wipe it away with a cloth. Check to see if the valve spool u-cups or the air valve housing is worn. If worn, replace with new components. Clean all ports and airways and replace worn out gaskets and o-rings.
3. Check pilot shaft and main shaft for scoring and scratches; replace if needed. Replace the pilot shaft and main shaft o-rings if they are worn, flat or torn.

The pump runs, but little or no material flows:

1. Check for pump cavitation, slow the pump speed down to match the thickness of the material being pumped.
2. Look for sticking ball checks. If the material being pumped is not compatible with the ball material, the elastomer may swell. Replace the balls and seats with a compatible elastomer type.
3. Make sure all the suction line fittings and connections are tight.

Air bubbles in pump discharge:

1. Look for a ruptured diaphragm.
2. Check for suction leaks in pump manifolds and piping.

Material comes out of the pump air exhaust:

1. Inspect the diaphragm for rupture.
2. Check the tightness of the diaphragm plates to the pump shaft.

TYPICAL INSTALLATIONS

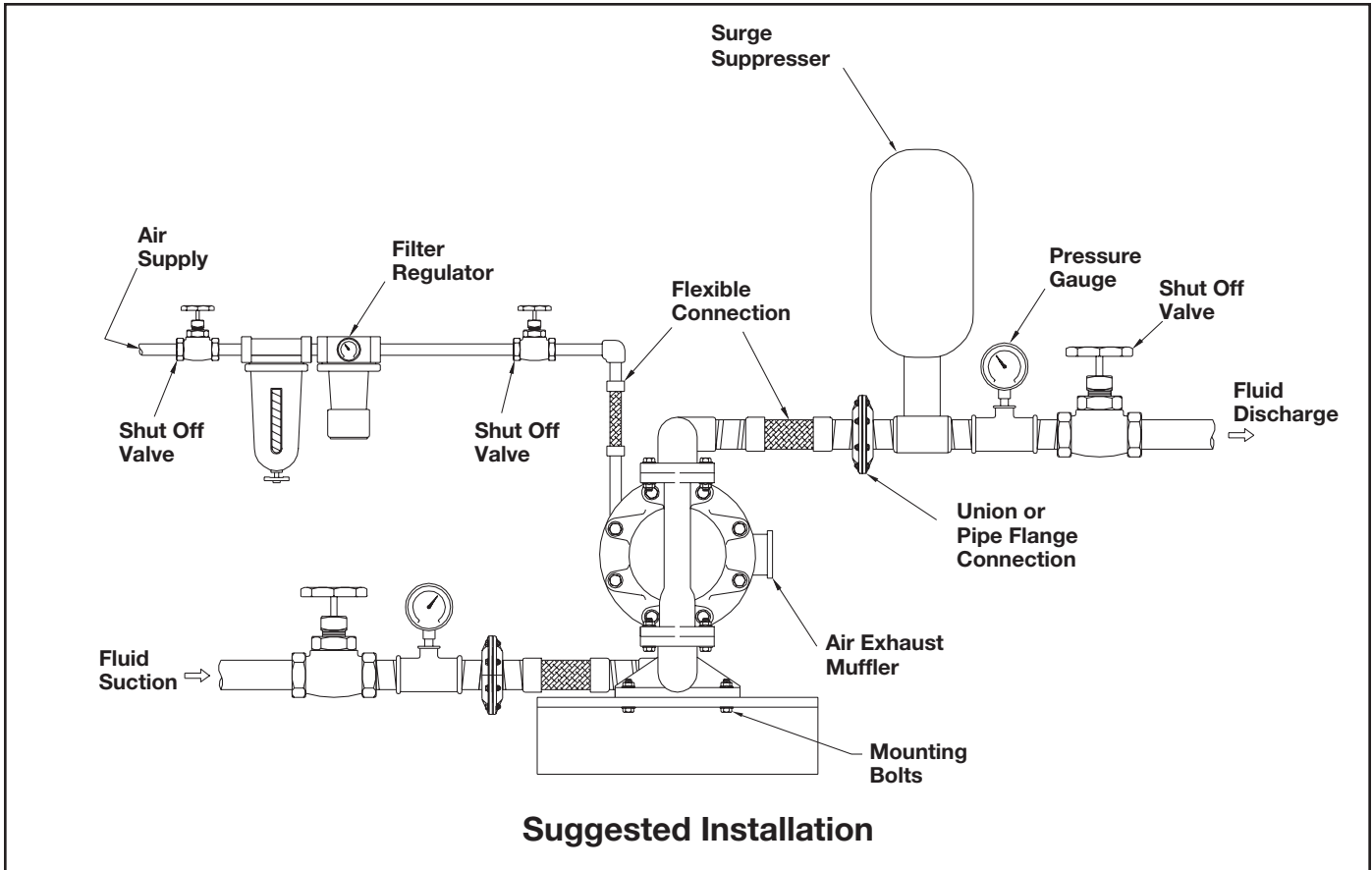

A typical installation showing all the components that are recommended in a system, including valves, pressure

gauges, air regulators, filters, and surge suppressors.

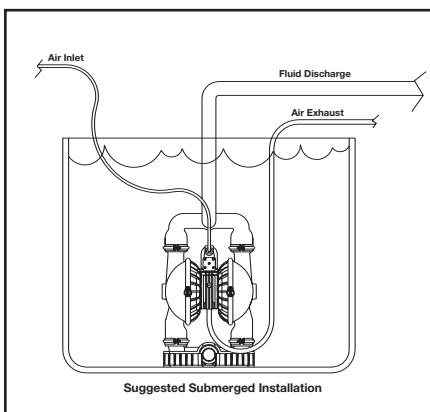

In a **submerged application**, the air exhaust port of the pump must be ported above the fluid line. Be certain that the fluid being pumped is compatible with the materials on both the airside and the wetted side of the pump before the pump is submerged.

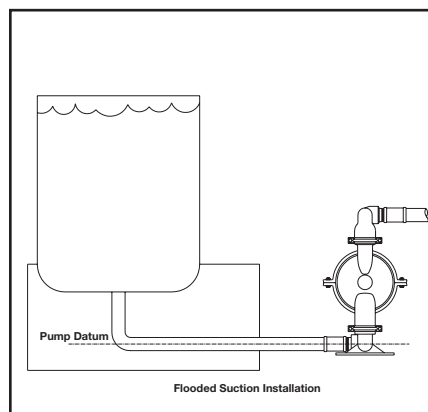

A **flooded suction installation** has the pump datum line below the fluid level. **IMPORTANT:** in flooded suction installations the pressure at the fluid inlet of the pump should never exceed 69 kPa (10 psi).

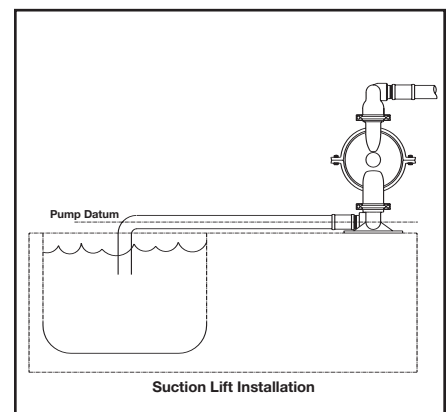

In **suction lift installations** the pump datum is above the fluid line. **IMPORTANT:** each pump has different lift capabilities. Be sure to verify the lift capability of a particular pump before installing it into a system.

Model 1120-015 1" UL Listed Pump Exploded View/Parts List

Item	Description	Qty.	Kit	Part#
1	Center Section	1		
2	Valve Assembly (Items 3-10)	1		
3	Valve Body	1		
4	Valve Spool	1		
4a	U-Cup	2	▲	
4b	Sleeve Bearing	2	▲	
4c	Sleeve O-Ring	2	▲	
5	End Cap Gasket	2	▲	
6	Air Valve Gasket	1	▲	
7	Valve Insert Plate	1	▲	
8	Air Diverter	1	▲	
9	End Cap	2		
10	Cap Screw	16		
11	Pilot Shaft Retainer	2		
12	Pilot Shaft	1		
14	Pilot Valve Ring	5	▲	
15	Pilot O-Ring	6	▲	
16	Elastic Stop Nut	2	▲	
17	Bushing O-Ring	2	▲	
18	Manifold Bolts	8		
19	Shaft	1		
20	Inner Diaphragm Plate	2		
21	Diaphragm	2	●	
22	Outer Diaphragm Plate	2		
23	Valve Ball	4	●	
24	Valve Seat	4		
25	Valve Seat O-Ring	4	●	
26	Water Chamber	2		
27	Inlet Manifold	1		
28	Discharge Manifold	1		
29	Connecting Nut	24		

Item	Description	Qty.	Kit	Part#
30	Connecting Washer	24		
31	Connecting Bolt	16		
32	Air Exhaust Muffler	1		
33	Grounding Strap	1		

Repair Kits & Replacement Parts

Wet End Kit (Buna / PTFE)	1		831621
Includes parts designated with a		●	
Air End Kit	1		831622
Includes parts designated with a		▲	
Buna-N Diaphragm			831598
PTFE Valve Ball			XXXXXX
Polypropylene Valve spool			831596
Muffler, 1/2" NPT Threads			831610

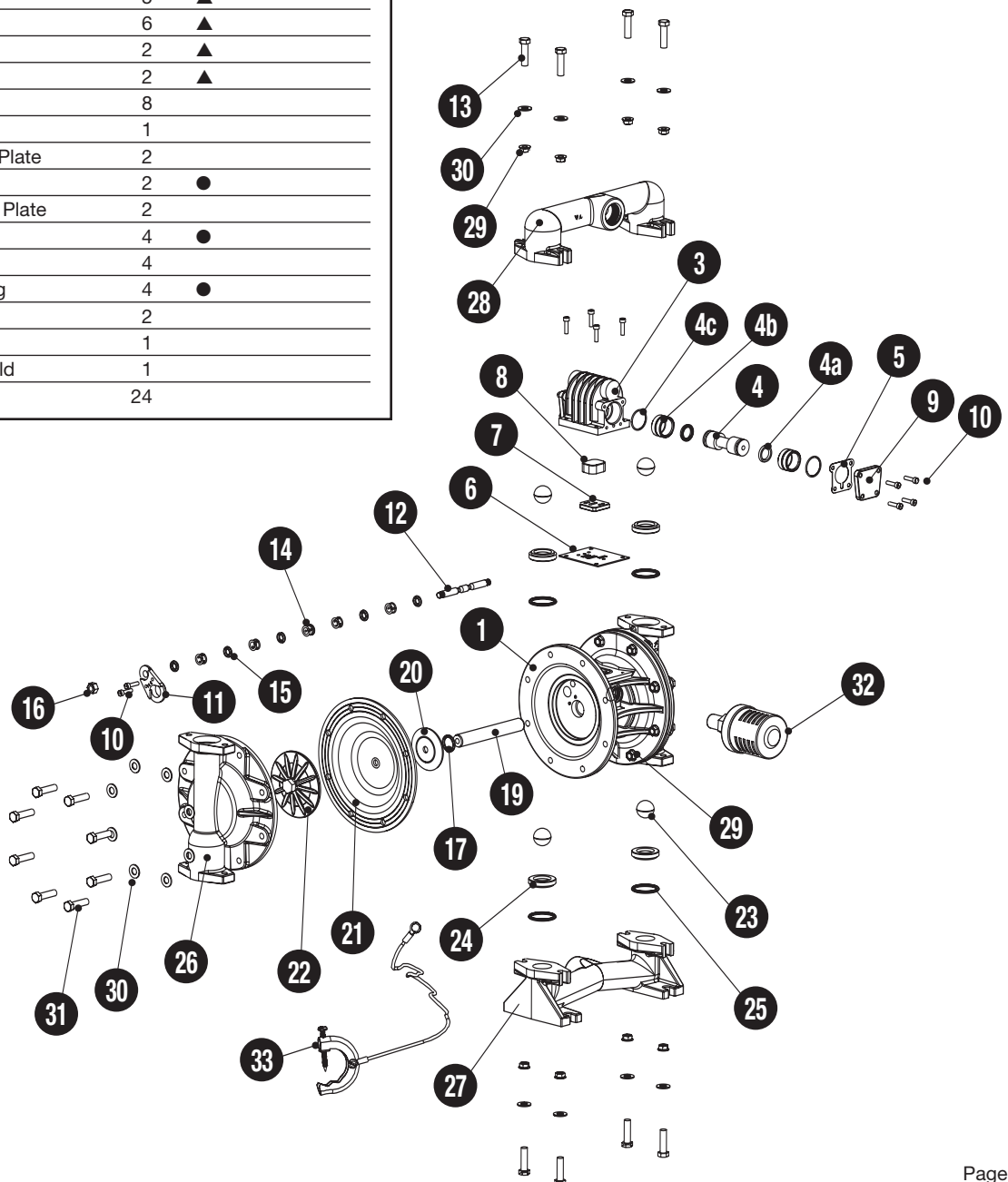

Safety Warnings

This equipment should only be maintained by experienced professional technicians. Observe all safety warnings. Read all safety warnings and operating manuals before using or repairing this Air Operated Diaphragm Pump.

Any misuse of this equipment such as over-pressurization, modifying parts, pumping incompatible fluids, using worn or damaged parts, or using gasses other than compressed air to power the pump is not recommended. Any of these circumstances could result in splashing or spraying into the eyes or on skin, possible serious bodily injury, fire, explosion, or property damage.

General Safety



ALWAYS wear safety glasses when using power tools to repair this equipment.



Wear proper ear protection when working or standing near A.O.D. pumps. It is recommended that an air exhaust muffler be used on this equipment at all times.

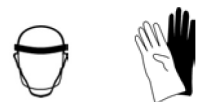

When the pumping system contains dangerous fluids, wear protective gloves, glasses, etc. when working on or around this equipment.

Always shut off the air supply and disconnect it from the pump before performing maintenance or repair on the pump.

Do NOT put your face or body near the pump air exhaust while the pump is operating.

Bleed all pressure from the discharge and suction lines before disconnecting the fluid suction or fluid discharge lines from the pump.

Before starting a pump, make certain that the discharge point of the piping system is clear and safe and all persons have been warned to stand clear.

Always make sure that safety shut off valves, regulators, pressure relief valves, gauges, etc. are working properly before starting the pump.

Equipment Misuse Hazard

Do NOT operate a pump that is leaking, damaged, corroded, or otherwise unable to contain the internal fluid pressure.

Do NOT pump incompatible fluids through the pump. Consult your distributor or the factory if you are not sure of the compatibility of fluids with the castings and elastomers.

Never exceed the operating pressure recommended for the pump: 50 psig (3.4 bar).

Do NOT submerge the pump in liquids that are incompatible with the wetted or non-wetted parts of the pump. If installing in a submerged location, extend the air exhaust port above the liquid surface with suitable pipe or hose. Route the exhaust line to a safe location away from people and install an air exhaust muffler.

A.O.D. pumps utilize an elastomeric membrane to separate the pumping liquid from the air supply. When this membrane ruptures, pumping fluid may be expelled from the air exhaust port. Always pipe the air exhaust port to a safe location or suitable container if dangerous or volatile liquids are being pumped.

Never allow the piping system to be supported by the pump manifolds or valve housing. The manifolds and valve housings are not designed to support any structural weight and failure of the pump may result. The use of flexible piping connections is highly recommended.

Do NOT exceed the recommended operating temperatures of the pump or pump failure may result.

Temperature Limitations

Maximum temperature limitations are based on mechanical stress only. Certain chemicals will reduce the maximum safe operating temperature of A.O.D. pumps. Consult your dealer or Chemical Resistance Guide for compatibility and temperature limits.

Polypropylene: 0°C (32°F) to 79°C (175°F)
Kynar: -12°C (10°F) to 107°C (225°F)

Do NOT exceed the maximum temperature limits of the elastomer type (diaphragms, balls, seats) that are used in the pump.

Temperature Limits of Various Elastomer Types:

Neoprene: -18°C (0°F) to 93°C (200°F)
Buna-N: -12°C (10°F) to 82°C (180°F)
Nordel: -51°C (-60°F) to 138°C (280°F)
Viton®: -40°C (-40°F) to 176°C (350°F)
PTFE: 4°C (40°F) to 105°C (220°F)
Polyurethane: -12°C (10°F) to 77°C (170°F)
Santoprene: -29°C (-20°F) to 149°C (300°F)
FDA Hytrel®: -29°C (-20°F) to 104°C (220°F)

Sound Level Ratings

1" Aluminum pumps (Model 1120-015) have a maximum decibel reading of 90.7 dB(A) when equipped with a factory installed air exhaust muffler.

The decibel readings are obtained with a Pacer Industries model SL-120, sound level indicator "A" scale. Readings are made at a distance of 1 meter from the pump and at a height of 1.6 meters above the floor. It is assumed that the pumps will be installed at floor level.

Moving Parts Hazard



The diaphragm plates (sometimes referred to as piston plates) located inside the pump on either side of the main shaft move when air pressure is supplied to the pump. Therefore, never attempt to operate the pump with the liquid chambers removed. Moving parts inside the pump can pinch or seriously injure fingers or other body parts.

Fire or Explosion Hazard

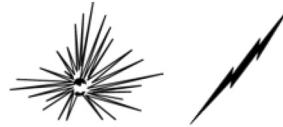

Static electricity can be created by the flow of fluid through the pump or by the reciprocating action of A.O.D. pumps. If the pump is not properly grounded, sparking may occur and the system may become hazardous. Sparks can ignite fumes or vapor and cause an explosion.

If you experience static sparking or even a slight shock while using the pump, do not continue to operate the pump until the pump is properly grounded.

Proper Grounding

To ground metallic pumps, connect a ground wire to any accessible point of attachment such as a connecting bolt or the mounting base.

REVISION LOG

SERVICE BULLETIN SB 1059
5/03 Original Release
10/03 Revised for UL79 standard
9/04 Revised Liquids Rated for Use
5/05 Revised New Air Section
7/07 Rev.1

WARRANTY

All Balcrank equipment sold through authorized Balcrank distributors is warranted to the original purchaser to be free from defects in materials and workmanship for a period of one year from the date the products were sold to the original purchaser. Select products carry extended warranty terms as individually noted within the Balcrank Lubrication Equipment & Accessories User Price List. Any Balcrank equipment carrying an extended warranty will be warranted for the period indicated; those items carrying a "lifetime" warranty are warranted for a period of thirty years. All Balcrank equipment determined by Balcrank to have defective materials or workmanship within the one year warranty period will be repaired or replaced. For equipment carrying extended warranties Balcrank will repair or replace the product including parts and labor for the first full year and will provide parts only for the remaining period of the specified warranty.

This warranty only covers equipment installed and operated according to applicable Balcrank Service Bulletins and Installation Instructions. Any equipment claimed to be defective must be returned freight prepaid to an Authorized Balcrank Service Center. If the part(s) or equipment is found to be defective, it will be repaired or replaced, and returned freight prepaid to the Authorized Service Center. If the claimed part(s) or equipment is found not to be defective, the Authorized Balcrank Service Center will, upon written authorization being received from the original purchaser repair them for a reasonable charge to the purchaser which will include all applicable parts, labor, and return transportation costs. Balcrank's sole responsibility is for defects in material and workmanship, and Buyer's sole and exclusive remedy hereunder, shall be limited to repair or replacement of the defective part or equipment.

This warranty does not cover, nor shall Balcrank be liable for, repair or replacement of parts or products resulting from general wear and through use, or damage or failure caused by improper installation, abuse, misapplication, abrasion, corrosion, insufficient or improper maintenance, negligence, accident, alteration, or substitution of non-Balcrank component parts. Furthermore, the Balcrank Warranty for Lubrication Equipment & accessories does not cover the following specific conditions:

- Failure or damage to equipment that is caused by dirt or debris in air and fluid lines. This includes, but is not limited to clogged inlet filters, strainers, or regulators; fluid meters; control handles; fluid tips; and valves.
- Failure of normal wear parts including but not limited to: O-rings, packings, seals, and valves unless originally improperly installed by the factory.
- Products placed in applications for which their use was not intended. Examples include, but are not limited to: a lubricant pump being used to pump solvents, or placing a piece of equipment intended strictly for indoor use in an outdoor application.
- Damage to equipment resulting from operation above and beyond Balcrank's recommendations.
- Leaks at air and fluid fittings and connections.
- Damage caused by thermal expansion when adequate pressure relief was not included in the system.
- Loose suction tubes on pumps.
- Reel spring tension adjustment.

THERE ARE NO OTHER WARRANTIES, EXPRESSED OR IMPLIED, INCLUDING WARRANTIES OF MERCHANTABILITY OR FITNESS FOR A PARTICULAR PURPOSE. IN NO EVENT SHALL BALCRANK BE LIABLE FOR ANY SPECIAL, CONSEQUENTIAL, OR OTHER DAMAGES OF A SIMILAR NATURE, INCLUDING BUT NOT LIMITED TO, LOST PROFITS, LOST PRODUCTION, PROPERTY DAMAGE, PERSONAL INJURY, WHETHER SUFFERED BY BUYER OR ANY THIRD PARTY, IRRESPECTIVE OF WHETHER CLAIMS OR ACTIONS, LEGAL OR EQUITABLE, FOR SUCH DAMAGES ARE BASED UPON CONTRACTS, WARRANTY, NEGLIGENCE, STRICT LIABILITY, OR OTHERWISE. ANY CLAIM OR ACTION FOR BREACH OF WARRANTY MUST BE BROUGHT WITHIN TWO (2) YEARS FROM THE DATE OF SALE TO THE ORIGINAL PURCHASER.

Distributed by:

Balcrank Corporation
Weaverville, NC 28787
800-747-5300
800-763-0840 Fax
www.balcrank.com